

UNO GOOSE NECK KITCHEN MIXER C/W POS

43931.xx

ELEMENTi

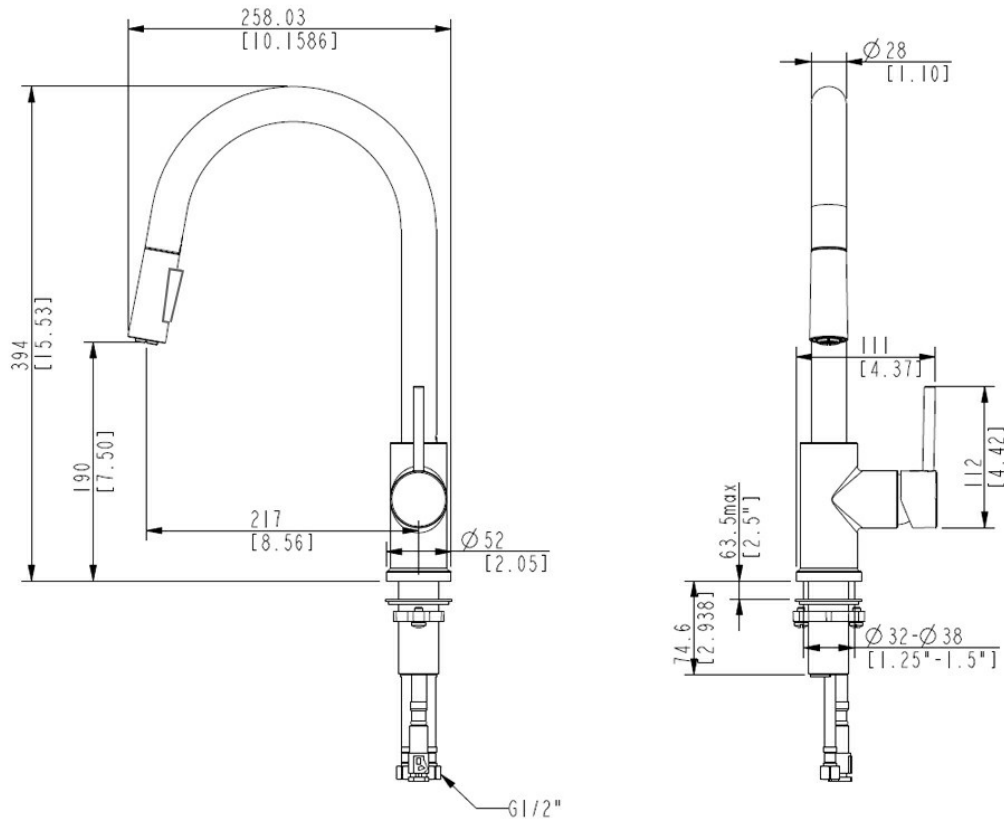

Check Stop

Ball valves with integrated check stop.



Residential/Light Commercial Use

Suitable for Residential/Light Commercial Use (Kitchens, Bathrooms and Laundries in Hotels, Motels and Retirement Villages).



Guarantee

5 Year Guarantee on coloured finish



Guarantee

10 Year Guarantee



4 Star WELS rating

More than 6.0 but not more than 7.5 litres per minute.



Mains Pressure

Suitable for Mains Pressure.



Flawless Finish

Advanced plating provides a durable surface with a long lasting finish



Effortless Control

Advanced cartridge technology provides a wide operating angle and smooth operation



Smooth Flow

Aerator reduces scaling while delivering a smooth even flow



Indicators

Includes standard and coloured indicators.

















Forward rotating handle

Forward rotating handle prevents the lever hitting the splashback.



Pull Out Spray

Make life easier with a pull out spray.

	5 Ticks Standards Mark	<p>The 5 Ticks Standards Mark™ certifies this product meet strict quality, safety, and performance standards.</p>
	Swivel Spout	The Swivel spout provides space, flexibility and ease of use.
	Chrome Plate	A base of copper is first applied followed by a layer of nickel and then finally a hard gloss coating of chromium to achieve a shiny hard wearing finish.
	Electroplated: Gun Metal	Electrical current is used to dissolve components into Lacquer that then adhere to the surface.
	Electroplated: Black	Electrical current is used to dissolve components into Lacquer that then adhere to the surface.
	Electroplated with PVD: Brushed Nickel	Electrical current is used to dissolve components into Lacquer that then adhere to the surface. A thin metal-spray coating in the form of very thin layers is finally applied using PVD process.
	Electroplated with PVD: Brushed Brass	Electrical current is used to dissolve components into Lacquer that then adhere to the surface. A thin metal-spray coating in the form of very thin layers is finally applied using PVD process.
	BPIR - Importer	Robertson NZ Ltd.
	BPIR - Place of Manufacture	Manufactured in China.
	BPIR - Relevance Documentation	For detailed information on Relevant Building Codes & Statement of Contribution please visit ROBERTSON.CO.NZ/DOWNLOADS and browse the relevant section
	BPIR - Scope of use	Kitchen mixers are used in residential kitchens to control water flow and temperature for sinks, facilitating everyday cooking and cleaning tasks.
	BPIR - B2.3.1 Durability	This product complies with Building Code Regulation B2.3.1 Durability
	BPIR - G12.3.2 (A) G12 Water Supplies	This product complies with Building Code Regulation G12.3.2 (A) G12 Water Supplies
	BPIR - G12.3.2 (B) G12 Water Supplies	This product complies with Building Code Regulation G12.3.2 (B) G12 Water Supplies
	BPIR - G12.3.7 G12 Water Supplies	This product complies with Building Code Regulation G12.3.7 G12 Water Supplies

The Uno collection offers a glamorous look without being too ostentatious. After years of chrome dominating as the must-have metal, there has been a move away from the high shine, perfect finish of Chrome towards finishes like Brushed Nickel, Gun Metal, Black and Brushed Brass.