

English Classic

Burlington®

DESCRIPTION

English Classic 1000 Wall-Hung Vanity – 2 Drawer, Matte English White

PRODUCT CODE

ENG100D2WH



FEATURES

- Dimensions: W1000 x H632 x D485 mm
- Available in single bowl: 600, 700, 800 and 1000mm widths
- Ceramic top with overflow from Europe.
- Cabinet features Edwardian design with matte English White paint finish or in your choice of custom matte or satin paint colour[^].
- The paint used on our products is polyurethane or UV based. It is five times harder and more durable than lacquer finishes.
- Soft-close drawers. New drawer heights offer storage variations.
- Traditional handles - available in polished chrome, satin black, antique bronze or antique pewter.
- Matches perfectly with our Burlington tapware & accessories range.

PAINT FINISH*



Matte
English
White



Custom
Matte or
Satin Paint[^]

HANDLE OPTIONS



Polished Chrome



Satin Black



Antique Bronze



Antique Pewter

NOTES

Refer to following page for technical drawings. *Non-stock item. [^]15% surcharge applies on custom matte paint colour. Tapholes do not come with predrilled – this is the responsibility of the installer, and can be cut with a hole saw, jigsaw or router. Excludes tapware & accessories.

MICHEL CÉSAR
VCBC
BURLINGTON
LAUNDRY

/ WHERE BATHROOMS
& LAUNDRIES
COME TOGETHER
BEAUTIFULLY /

info@smail.co.nz
bathco.co.nz

4-8 Ace Place
Kingsland
Auckland 1021
New Zealand

P +64 9 309 9109
F +64 9 309 9343

86 Wigram Road
P.O. Box 8644
Christchurch 8025
New Zealand

P +64 3 343 0969
F +64 3 343 0967

BATH/
CO/

English Classic

Burlington®

DESCRIPTION

English Classic 1000 Wall-Hung Vanity – 2 Drawer, Matte English White

PRODUCT CODE

ENG100D2WH

TECHNICAL DRAWINGS

Top

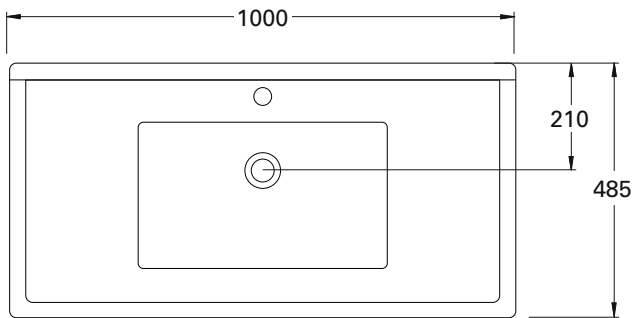

Top Section

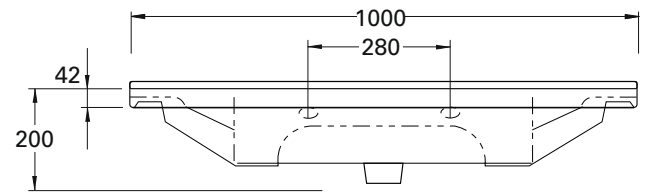

Front

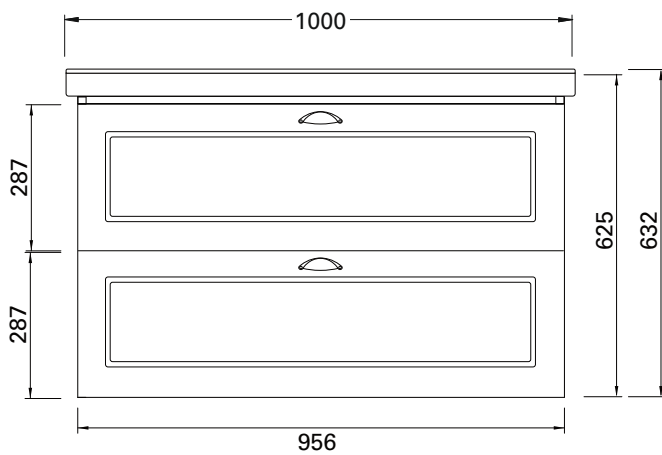

Side

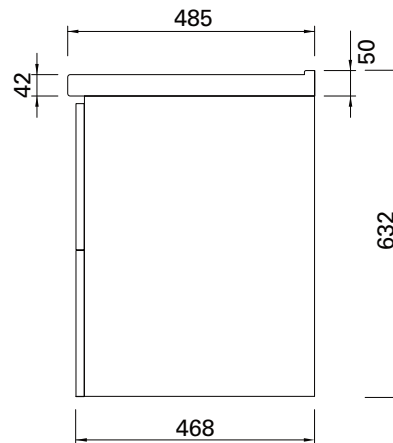

NOTES

Drawing indicates the technical measurement only and is not a reflection of how the unit will look. Sizes are nominal only. All drawings in millimeters. Drawings not to scale.