

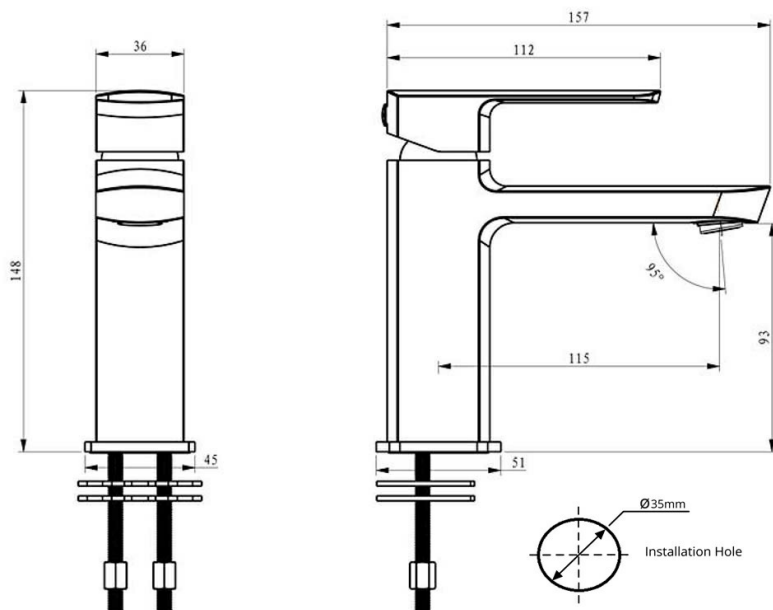















## ION BASIN MIXER

44251.xx

ELEMENTI



	Residential/Light Commercial Use	Suitable for Residential/Light Commercial Use (Kitchens, Bathrooms and Laundries in Hotels, Motels and Retirement Villages).
	Guarantee	5 Year Guarantee on coloured finish
	Guarantee	10 Year Guarantee
	4 Star WELS rating	More than 6.0 but not more than 7.5 litres per minute. Mains Pressure
	5 Star WELS rating	More than 4.5 but not more than 6 litres per minute. Low/Unequal pressure
	Mains Pressure	Suitable for Mains Pressure.
	Multi Pressure	Suitable for Multi Pressure.
	Flawless Finish	Advanced plating provides a durable surface with a long lasting finish
	Effortless Control	Advanced cartridge technology provides a wide operating angle and smooth operation
	Smooth Flow	Aerator reduces scaling while delivering a smooth even flow
	Indicators	Includes standard and coloured indicators.
	Chrome Plate	A base of copper is first applied followed by a layer of nickel and then finally a hard gloss coating of chromium to achieve a shiny hard wearing finish.
	Electroplated: Gun Metal	Electrical current is used to dissolve components into Lacquer that then adhere to the surface.
	Electroplated: Black	Electrical current is used to dissolve components into Lacquer that then adhere to the surface.
	Electroplated: Brushed Nickel	Electrical current is used to dissolve components into Lacquer that then adhere to the surface.

With flat profiling of the lever and spout combined with sleek lines and stylishly good looks, the new ION tapware collection from Elementi is a superior product in both looks (available in 5 finishes) and performance.