

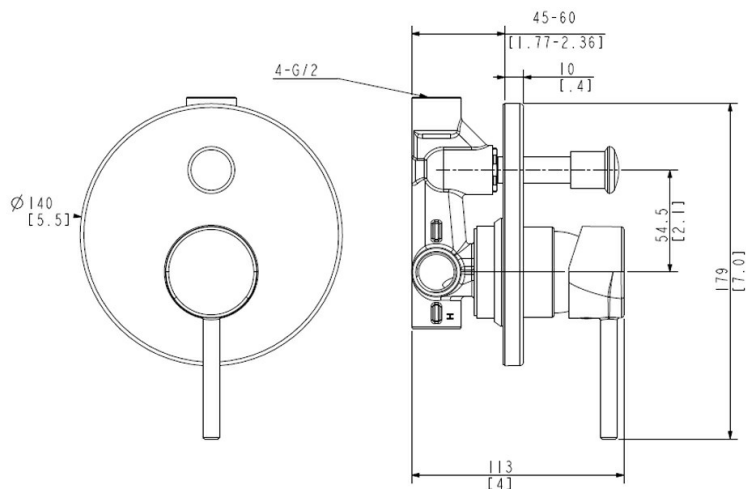









UNO DIVERTER MIXER

42971.xx

ELEMENTI



5	Guarantee	5 Year Guarantee on coloured finish
10	Guarantee	10 Year Guarantee
	Mains Pressure	Suitable for Mains Pressure.
	Flawless Finish	Advanced plating provides a durable surface with a long lasting finish
	Effortless Control	Advanced cartridge technology provides a wide operating angle and smooth operation
	Smooth Flow	Aerator reduces scaling while delivering a smooth even flow
	Chrome Plate	A base of copper is first applied followed by a layer of nickel and then finally a hard gloss coating of chromium to achieve a shiny hard wearing finish.
	Blackened Oil Bronze: Black	Parts are firstly nickel plated then blackened oxidation process to apply the base colour. and a transparent liquid polymer is applied achieve a mat finish and hardened surface.
	Electroplated: Gun Metal	Electrical current is used to dissolve components into Lacquer that then adhere to the surface.
	Electroplated with PVD: Brushed Nickel	Electrical current is used to dissolve components into Lacquer that then adhere to the surface. A thin metal-spray coating in the form of very thin layers is finally applied using PVD process.
	Electroplated with PVD: Brushed Brass	Electrical current is used to dissolve components into Lacquer that then adhere to the surface. A thin metal-spray coating in the form of very thin layers is finally applied using PVD process.

The Uno collection offers a glamorous look without being too ostentatious. After years of chrome dominating as the must-have metal, there has been a move away from the high shine, perfect finish of Chrome towards finishes like Brushed Nickel, Gun Metal, Black and Brushed Brass.