

SPECIFICATIONS

Lavage Duo Vanities



- Suits 1 centre vessel basin

Lavage Duo 750 2 Drawer Vanity
LAVO75W • 750W x 460D x 520H



- Suits 1 centre vessel basin

Lavage Duo 900 2 Drawer Vanity
LAVO90W • 900W x 460D x 520H



- Suits 1 or 2 vessel basins (specify placement when ordering)

Lavage Duo 1200 2 Drawer Vanity
LAVO120W • 1200W x 460D x 520H



- Suits 1 or 2 vessel basins (specify placement when ordering)

Lavage Duo 1200 2 Drawer Vanity
LAVO120SD • 1200W x 460D x 370H

1200mm (2 Drawer)

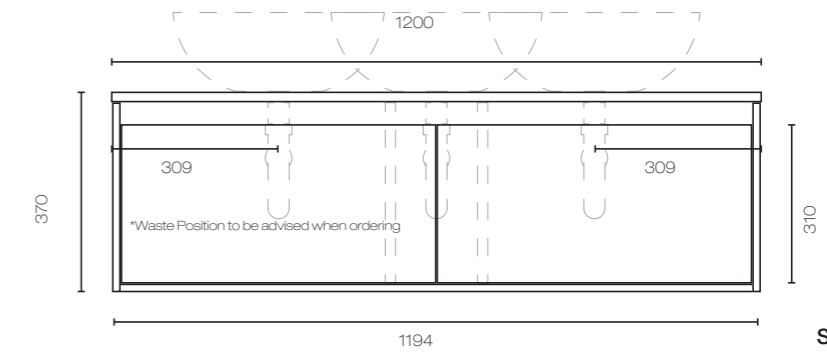

Side View



- Suits 1 or 2 vessel basins (specify placement when ordering)

Lavage Duo 1500 2 Drawer Vanity
LAVO150SD • 1500W x 460D x 370H

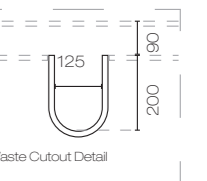

1500mm

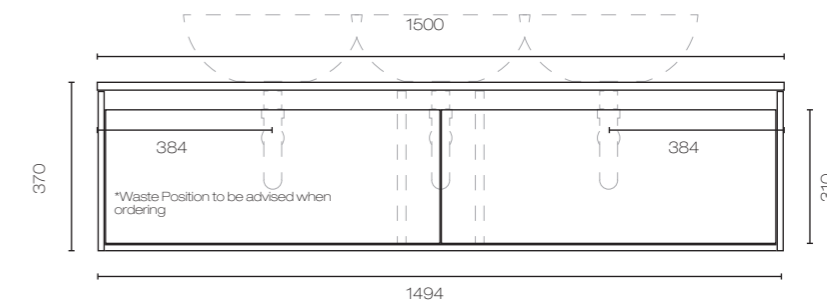

Side View 750mm

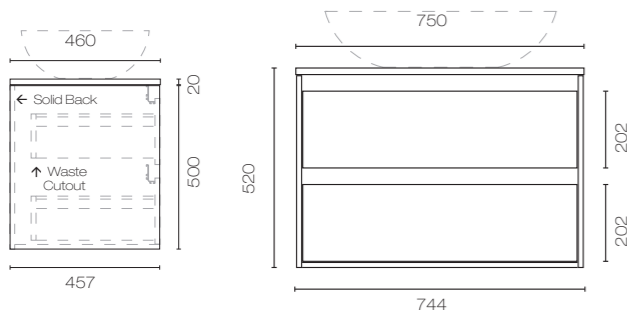

900mm

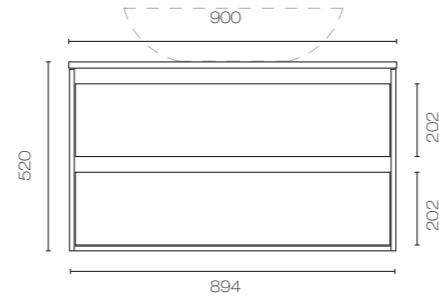

1200mm (2 Drawer)

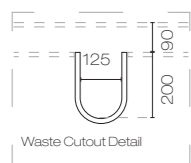
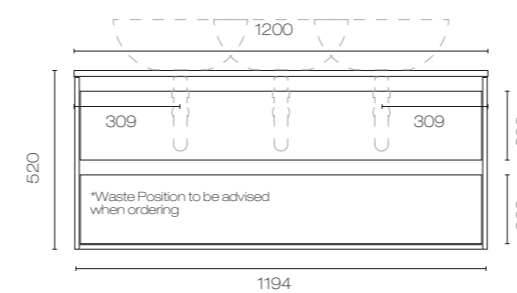

NOTE:
Specify basin placement when ordering

Installers Note

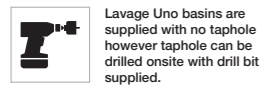

Lavage Uno basins are supplied with no taphole however taphole can be drilled onsite with drill bit supplied.